

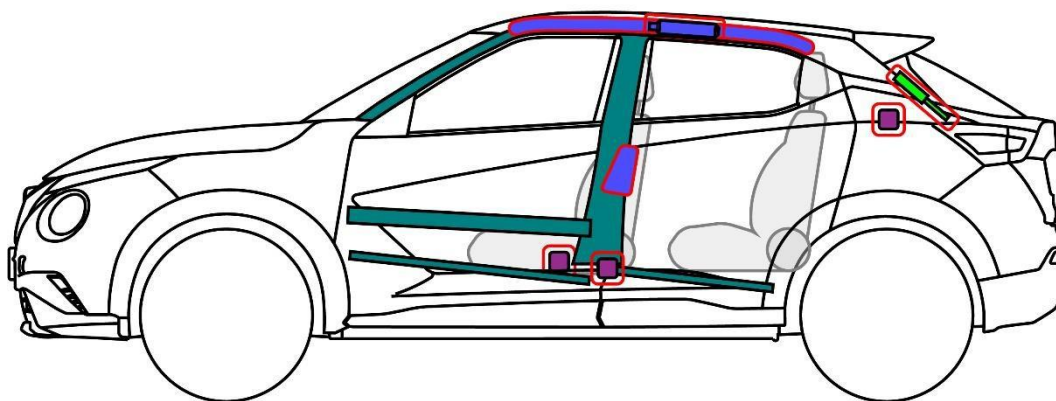

NISSAN

Juke

Tip: F16, 5-vrata SUV
(2019 -)

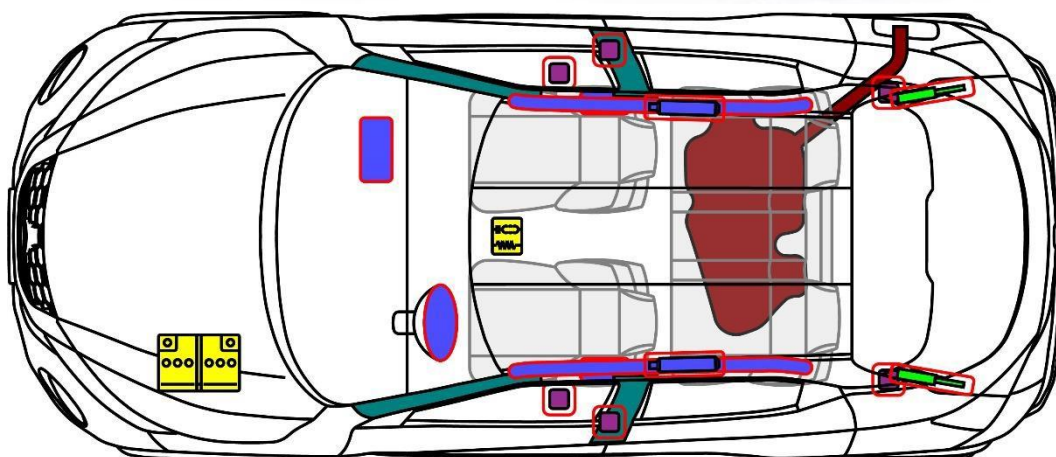

	Vazdušni jastuk		Plinski generator		Zatezač sigurnosnog pojasa		SRS kontrolna jedinica		Sistem za zaštitu pešaka
	Automatski sistem zaštite od prevrtanja		Plinsko hidraulični podizač / zategnuta opruga		Zona visoke otpornosti		Zona koja zahteva posebnu pažnju		
	Akumulator niskog napona		Ultrakondenzator niskog napona		Rezervoar za gorivo		Rezervoar za gas		Sigurnosni ventil
	Akumulatorski paket visokog napona		Visokonaponski električni kabl		Visokonaponski uređaj koji isključuje visoki napon		Kutija sa osiguračima za isključivanje visokog napona		Ultrakondenzator visokog napona
	Rezervoar za gorivo / etanol								

1. Identifikacija



2. Imobilizacija / stabilizacija / dizanje

Imobilizacija vozila:

1. Blokirajte točkove
2. Za automatski menjač odabrati (P) položaj parkiranja
3. Aktivirajte kočnicu za parkiranje
4. Pritisnuti dugme Start/Stop



Pristupne tačke za podizanje

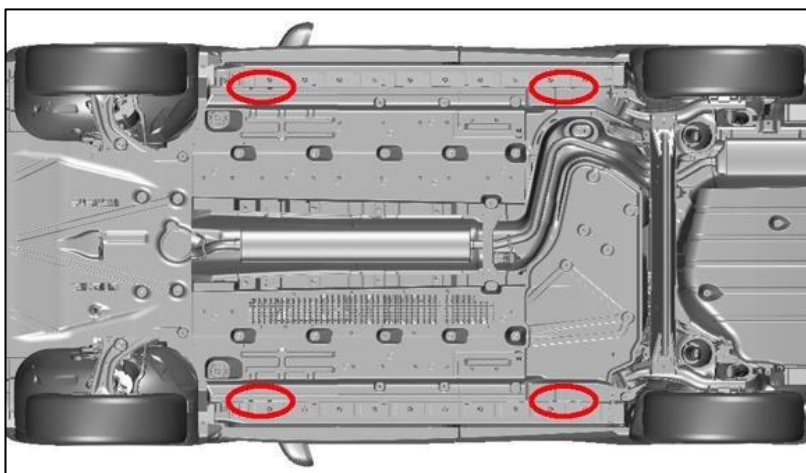

3. Bezbednosni propisi / sprečavanje opasnosti

Pristup motornom prostoru



Isključite akumulator (12 V)

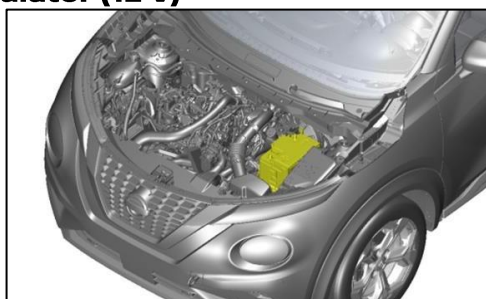
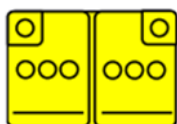

1. Isključite kontakt
2. Odvojite negativni priključak (-)
3. Odvojite pozitivan priključak (+)

4. Pristup putnicima u vozilu

Delovi u karoseriji od čelika

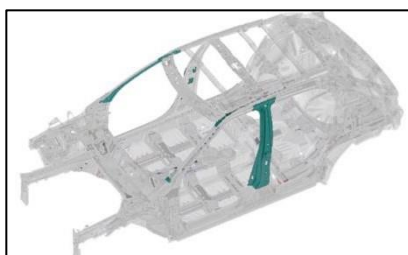

Delovi u vratima od čelika

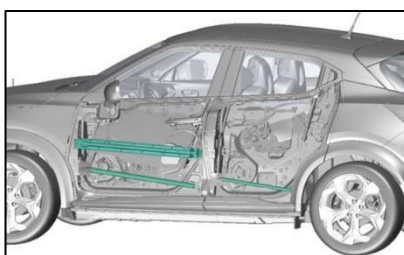

Podešavanje stuba upravljača



Podešavanje sedišta











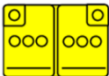

Vrsta stakla:

- A. Laminirano staklo
- B. Kaljeno staklo



5. Akumulirana energija / tečnosti / gasovi / čvrste materije

	12V	 
	R-1234yf 450 ±25 g	   
	46 L	 

6. U slučaju požara



KORISTITE VELIKE KOLIČINE VODE



GASNI AMORTIZER, RIZIK OD EFEKTA PROJEKTILA

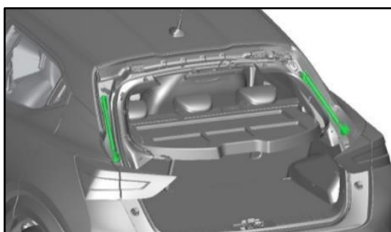

8. Vuča / transport / skladištenje

Skladištenje kuke za vuču



Pozicija prednje kuke













Pozicija zadnje kuke



10. Objašnjenje piktograma



	Upozorenje		Zapaljivo
	Upozorenje na nisku temperaturu		Opasno po ljudsko zdravlje
	Rashladni fluid za klima uređaj		Eksplzivno
	Hibridno električno vozilo na gorivo tipa 2		Korozivne supstance
	Prtljažnik		Upotreba vode prilikom gašenja požara